



RICHENG FOODSTUFF MACHINERY CO.,LTD

ADD: Jiangyi Industrial District, Shunde Foshan City, Guangdong Province, China

Tel: +86-757-25666837

Fax: +86-757-25668837

Web: www.ri-cheng.com.cn Email: info@ri-cheng.com.cn; export@ri-cheng.com.cn

Mobile: +86-13703082992 Mr. Gordon.Liao



ABOUT RICHENG since 1999



Richeng Foodstuff Machinery Co.,Ltd:

- 1. Full Automatic Biscuit Feeding--Creaming--Packing System**
- 2. Biscuit Cream Sandwiching With Pile And On Edge Packing System**
- 3. Cream Mixer And Chocolate/Jam Depositor**
- 4. All Kinds Of Conveyor System (Cooling Conveyor, Turning Conveyor, Secondary Conveyor)**



RICHENG FOODSTUFF MACHINERY CO.,LTD

ADD: Jiangyi Industrial District, Shunde Foshan City, Guangdong Province, China

Tel: +86-757-25666837





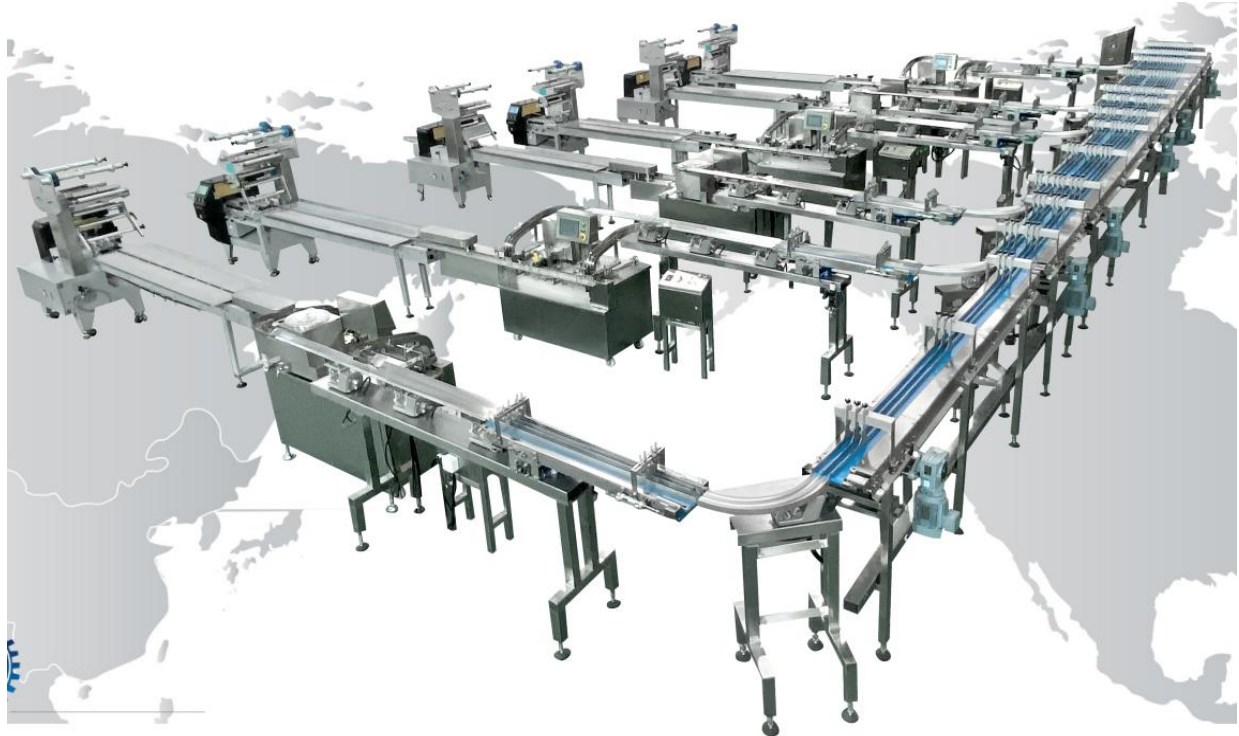
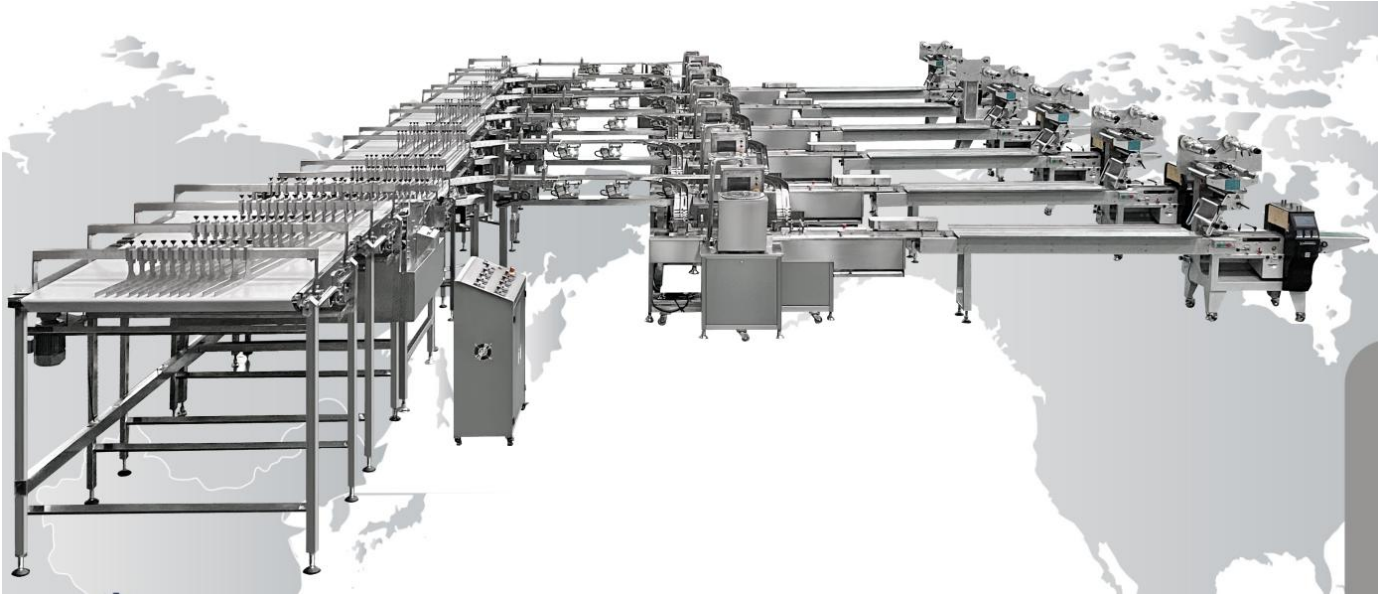

Fax: +86-757-25668837

Web: www.ri-cheng.com.cn Email: info@ri-cheng.com.cn; export@ri-cheng.com.cn

Mobile: +86-13703082992 Mr. Gordon.Liao

Full Automatic Biscuit Feeding--Creaming--Packing System



	One color	Two color	3+2 sandwiches	Cream+jam
Cream type				
Package type (On Edge pack)		Package type (Pile pack)		



RICHENG FOODSTUFF MACHINERY CO.,LTD

ADD: Jiangyi Industrial District, Shunde Foshan City, Guangdong Province, China

Tel: +86-757-25666837

Fax: +86-757-25668837

Web: www.ri-cheng.com.cn Email: info@ri-cheng.com.cn; export@ri-cheng.com.cn

Mobile: +86-13703082992 Mr. Gordon.Liao

Biscuit Cream Sandwiching

Automatic With On Edge Packing System

Four lane biscuit sandwiching connect on edge packing machine



Double lane biscuit sandwiching connect on edge packing machine

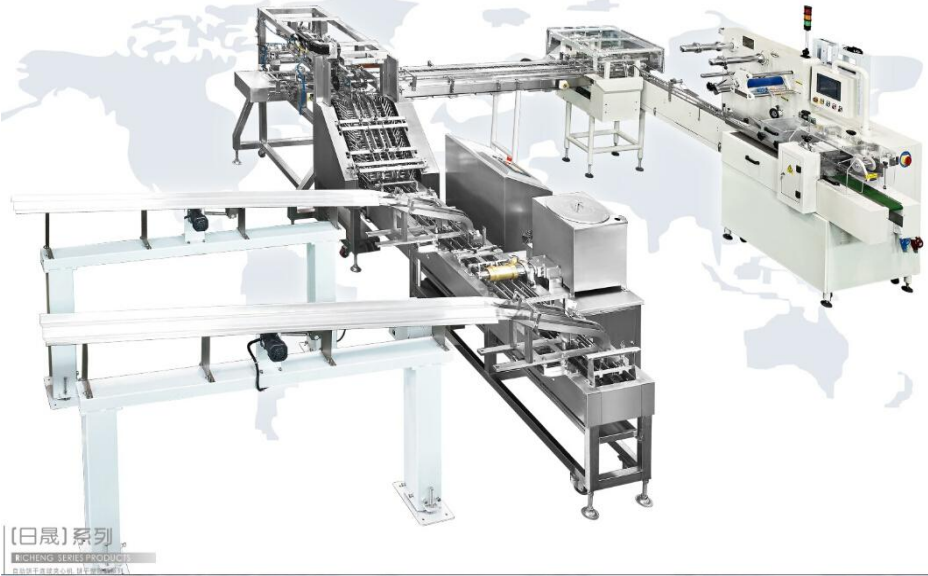

One color

Two color

3+2 sandwiches

Cream+jam

Cream type



Package type
(On edge pack)





RICHENG FOODSTUFF MACHINERY CO.,LTD

ADD: Jiangyi Industrial District, Shunde Foshan City, Guangdong Province, China

Tel: +86-757-25666837

Fax: +86-757-25668837

Web: www.ri-cheng.com.cn Email: info@ri-cheng.com.cn; export@ri-cheng.com.cn

Mobile: +86-13703082992 Mr. Gordon.Liao

Biscuit Cream Sandwiching

Automatic With Pile/Pillow Packing System

**Double lane
Biscuit
sandwiching
connect pile
packing machine**

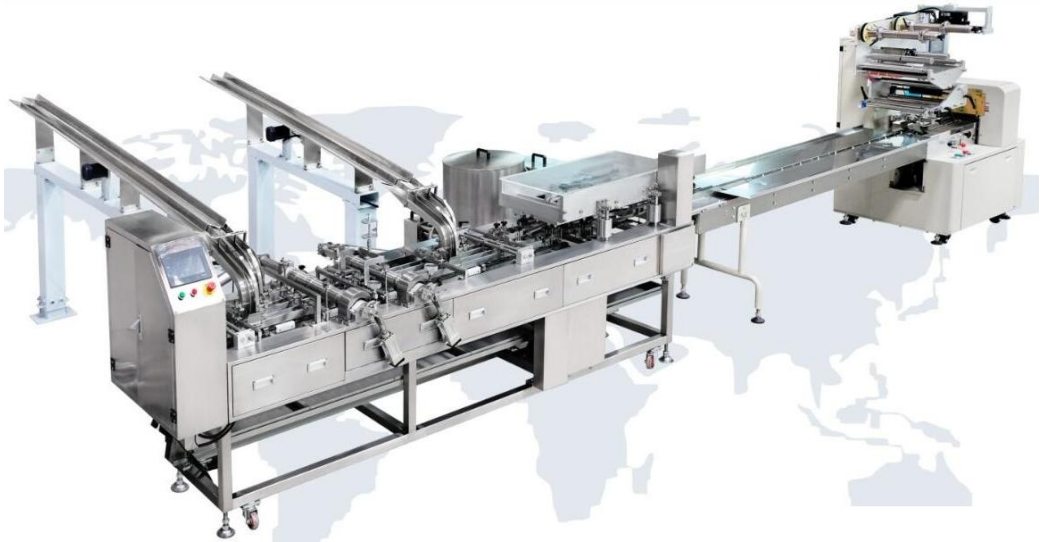

**Single lane Biscuit
sandwiching
connect pile
packing machine**



One color

Two color

3+2 sandwiches

Cream+jam

Cream type



**Package type
(Pile/Pillow pack)**



Special





RICHENG FOODSTUFF MACHINERY CO.,LTD

ADD: Jiangyi Industrial District, Shunde Foshan City, Guangdong Province, China

Tel: +86-757-25666837

Fax: +86-757-25668837

Web: www.ri-cheng.com.cn Email: info@ri-cheng.com.cn; export@ri-cheng.com.cn

Mobile: +86-13703082992 Mr. Gordon.Liao

1/2/4/6 Lane Biscuit Cream Sandwiching Machine

Four lane Biscuit sandwiching machine

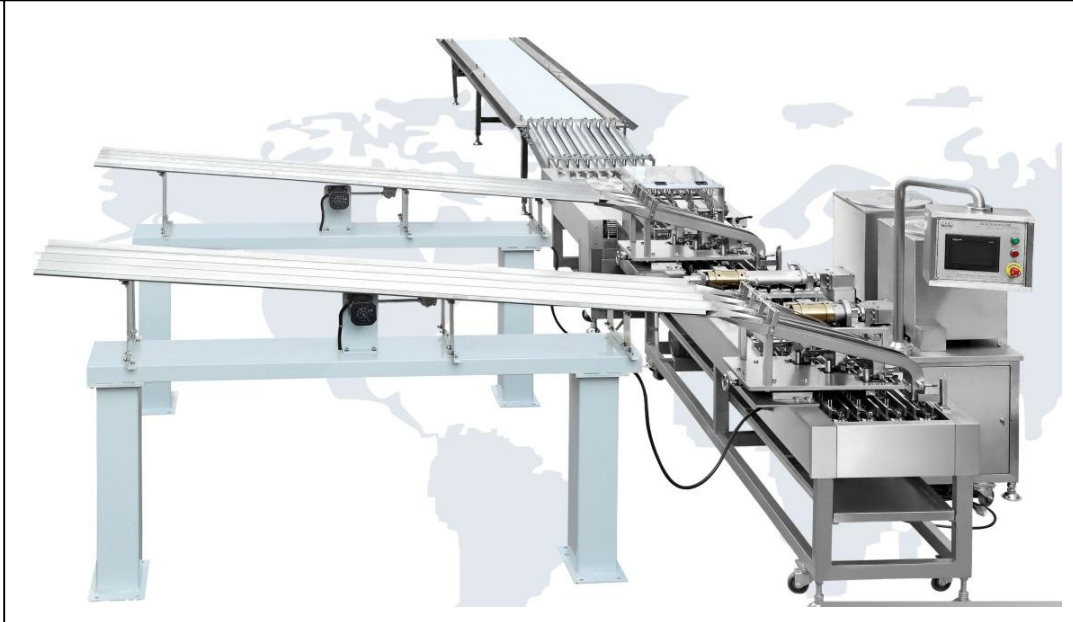

Double lane Biscuit sandwiching machine



Row/Lane Multiplier

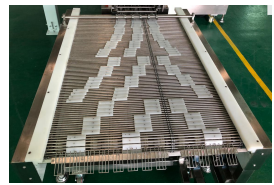
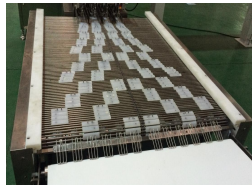
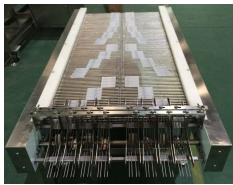

Cream type

One color



Two color



3+2 sandwiches



Cream+jam



Chocolate coating





RICHENG FOODSTUFF MACHINERY CO.,LTD

ADD: Jiangyi Industrial District, Shunde Foshan City, Guangdong Province, China

Tel: +86-757-25666837

Fax: +86-757-25668837

Web: www.ri-cheng.com.cn Email: info@ri-cheng.com.cn; export@ri-cheng.com.cn

Mobile: +86-13703082992 Mr. Gordon.Liao

Cream Mixer

**Vertical type
Capacity 150kgs**



**Horizontal type
Capacity 80kgs**





RICHENG FOODSTUFF MACHINERY CO.,LTD

ADD: Jiangyi Industrial District, Shunde Foshan City, Guangdong Province, China

Tel: +86-757-25666837

Fax: +86-757-25668837

Web: www.ri-cheng.com.cn Email: info@ri-cheng.com.cn; export@ri-cheng.com.cn

Mobile: +86-13703082992 Mr. Gordon.Liao

Biscuit Stacking Machine



Biscuit Chocolate/Jam Depositor





RICHENG FOODSTUFF MACHINERY CO.,LTD

ADD: Jiangyi Industrial District, Shunde Foshan City, Guangdong Province, China

Tel: +86-757-25666837

Fax: +86-757-25668837

Web: www.ri-cheng.com.cn Email: info@ri-cheng.com.cn; export@ri-cheng.com.cn

Mobile: +86-13703082992 Mr. Gordon.Liao

Cooling Conveyor



90° / 180° Turning Conveyor / Wire Mesh Conveyor

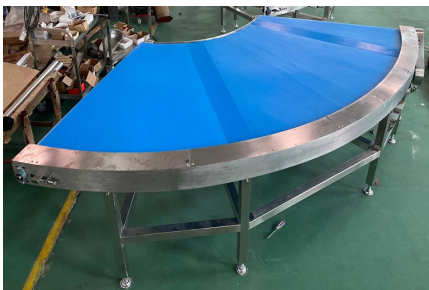

Secondary Conveyor

